

Configuration and Setting guide



ONE Compact

REF. 2870



Index

1. INTRODUCTION	3
1.1 Introduction to general safety	3
1.2 Recommendations regarding the installation environment.....	4
1.3 Module description.....	4
1.3.1 General description	4
1.3.2 Main characteristics	5
2. CONTENTS OF THE PACKAGE	5
3. USER'S GUIDE FOR THE APPLICATION	6
3.1 Requirements.....	6
3.2 Connect your Android device to the ONE Compact.....	6
3.3 Programme the ONE Compact using your android device.....	7
3.3.1 Configuration of the filters (Add/delete/Edit channel).....	7
3.3.2 Output adjustments (Output level/Slope).....	10
3.3.3 Maintenance.....	10
3.3.4 System information	13
3.3.5 Restoring default settings	13
4. LIST OF CHANNELS AND FREQUENCIES	14
4.1 Europe.....	14
4.2 Australia	15
4.3 New Zealand	16
4.4 Mexico.....	17
4.5 Brazil.....	18
4.6 Thailand.....	19
5. EQUIPMENT RECYCLING	20

1. INTRODUCTION

This document explains how to install the programmable amplifier unit ONE Compact.

The document describes how the amplifier unit is configured. To do this, initially, the physical assembly is explained. Following this, it explains how to connect it to an android device and all the configuration options are presented. Finally, the different channels with which the ONE Compact can function are shown.

For a correct use and installation of the amplifier unit, please read the manuals included in the box.

1.1 Introduction to general safety

Please read this user manual carefully and fully before connecting the equipment to the mains power supply. Always keep these instructions handy during the installation.

Follow the safety instructions and warnings referring to handling the equipment.



Danger of death or injury

This safety warning indicates possible danger to people's lives and health. If these indications are not observed, serious consequences may occur, which could even cause fatal injuries.

Do not install the equipment during an electrical storm. There could be a risk of electric shock due to lightning.

Do not open the equipment. There is a risk of electric shock.



Risk of damaging the equipment

This safety warning indicates a possibly hazardous situation. If these indications are not observed, material damage could be caused to the equipment.

The equipment needs to be correctly ventilated. Install the equipment in a dust-free place. Do not place the equipment in an area where the ventilation slots are covered or obstructed. Install the equipment in a place with a minimum distance of 20 cm without any obstacles around it.

Do not expose the equipment to rain or damp. Install the equipment in a dry place with no water filtrations and condensation. If a liquid leaks inside the equipment, immediately disconnect the AC mains supply.

Keep the equipment away from inflammable objects, candles and anything that could cause a fire.

Connect the equipment to a mains input cable that is easily accessible. In this way, in case of emergency, the equipment may be disconnected quickly from the mains.

Do not expose the equipment to heat sources (sun, heating, etc.)



Do not manipulate the inside of the equipment

This warning is a prohibition against carrying out any task that could affect the working of the equipment or of its warranty.



Do not dispose of as urban waste

This type of warning indicates that the equipment must not be disposed of as unselected urban waste.



NOTE

This type of warning is a note with application advice and useful information for the correct use of the equipment.

1.2 Recommendations regarding the installation environment

- The equipment must only be used in indoor environments.
- Do not plug in the equipment in damp rooms.
- Do not turn the equipment on immediately after moving it from a cold place to one where there is a high temperature. When the equipment is exposed to a sudden change in temperature, the humidity may condense on the essential internal components.
- The equipment must be well-ventilated and must not be covered.
- Protect the equipment against direct sunlight, heat, sudden changes in temperature and damp.
- Do not place the device close to heaters or air conditioning units.
- Do not let any liquid penetrate the equipment. Turn the equipment off and unplug it from the mains electricity if any liquid or foreign substances enter the device.
- If the equipment heats up too much or gives off smoke, immediately turn it off and unplug the power supply cable. Take the device to be inspected at a technical assistance centre.
- In the following conditions a layer of humidity may appear inside the equipment that may cause it to malfunction:
 - If the equipment is moved from a cold place to one where there is a high temperature;
 - After heating up a cold room;
 - When the equipment is placed in a damp room.
- The equipment must not be used in a very dusty or saline environment. The dust or salt particles and other foreign objects may damage the equipment.
- Do not expose the equipment to extreme vibrations. This may damage the internal components.

1.3 Description of the module

1.3.1 General description

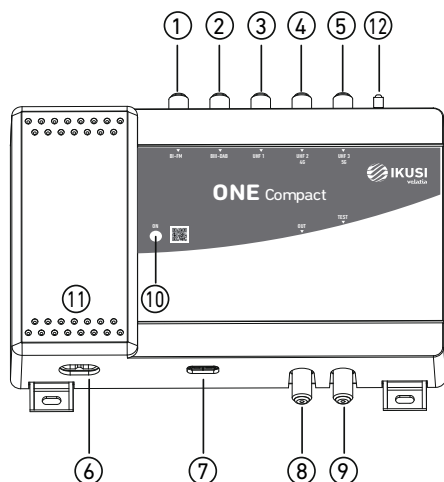

KEY

- 1 BI-FM input
- 2 BIII-DAB input
- 3 UHF1 input
- 4 UHF2 input
- 5 UHF3 input
- 6 AC connector
- 7 USB connector
- 8 TV output
- 9 Output test
- 10 LED operation indicator
- 11 Power supply
- 12 Grounding

1.3.2 Main characteristics

ONE Compact is a programmable unit that filters, combines, converts, equalises and amplifies television signals received by an aerial. Suitable for single homes or apartment blocks, it is the perfect solution for managing signals of different frequencies and amplitudes.

In addition to UHF signals, FM and VHF signals are also amplified. The individual adjustment of each filter allows adaptation to the specific situations of each specific TV channel, as well as offering the possibility of being able to work in conversion mode, transferring the TV channel to a frequency that is different than the original one. The input power reading system allows the levels of the output channels to be equalised automatically.

The most relevant characteristics of the ONE Compact units are the following:

- 32 filters for processing or converting terrestrial TV channels.
- Integrated pre-amplifier and automatic control gain to equalise incoming signals with important variations.
- Inputs to select the best signal from each aerial.
- 4G and 5G filters to minimise interference from mobile telephone systems.
- Adjustable output level up to 113 dB μ V.
- Configuration with tablets or smart phones using Android application.

2. CONTENTS OF THE PACKAGE

- Central ONE Compact with integrated power supply inside the plastic casing.



- Mains supply cable



- OTG cable (microUSB to type A USB)



 The connection between the Android device and the ONE Compact unit must be exclusively made using the supplied OTG cable; otherwise it will NOT work properly.

3. USER'S GUIDE FOR THE APPLICATION

3.1 Requirements

- Download the "ONE Compact" application from Google Play
- Android 5.0 or higher is necessary
- OTG cable
- ONE Compact Unit



3.2 Connect your Android device to the ONE Compact Unit

Connect your Android device to the unit using the OTG cable. Open the "ONE Compact" application

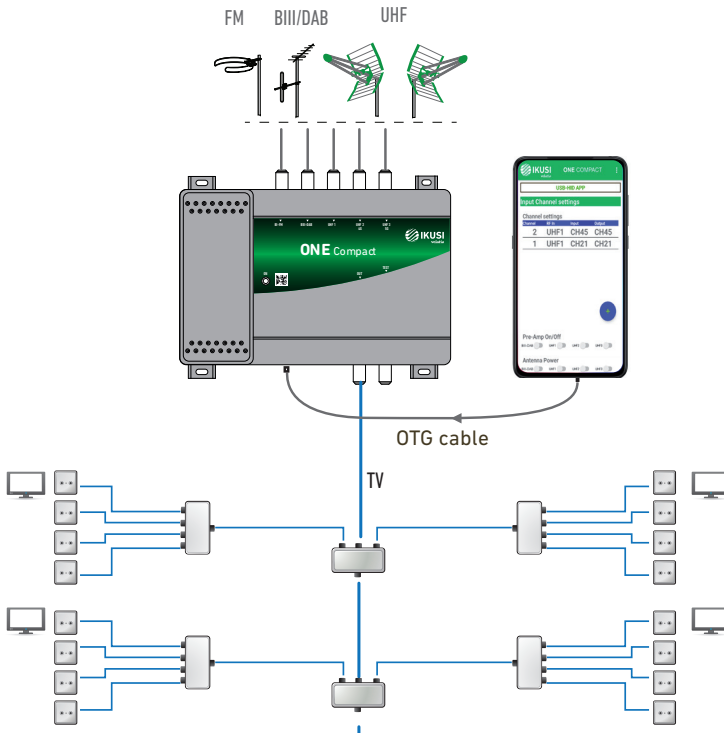

Now the ONE Compact unit is ready for programming using your Android device.

**NOTE**

Allow the APPLICATION access the android device's storage to use other functions (save, load configuration...), while connecting the OTG cable and the ONE Compact. Select when the application asks this. This step will only be necessary the first time the application is launched.

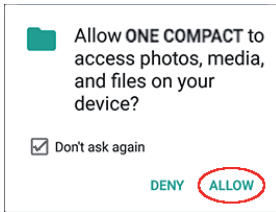

3.3 Programme the ONE Compact using your android device

3.3.1 Configuration of the filters (Add/Delete/Edit channel)

When the user connects their device to the ONE Compact, the application will check and synchronise with the device after the connection has been made. This will take approximately 3 seconds.

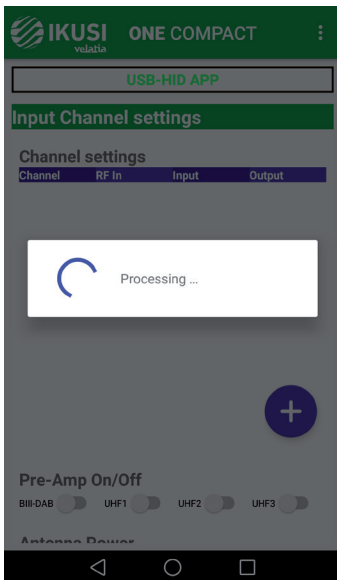

• **Add a channel**

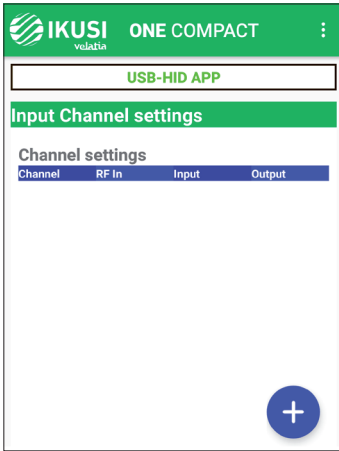

→ Press the + button to add a new channel

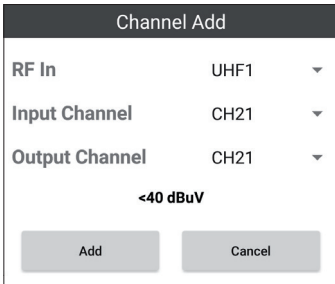

→ Select the input aerial

→ Select the input channel

→ Select the output channel

Press the  button

• **Delete a channel**

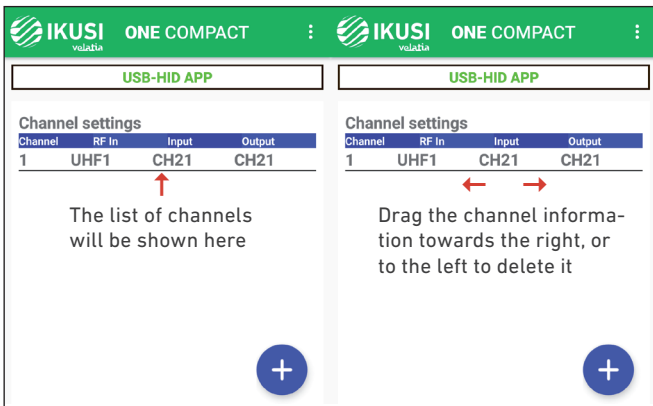

• **Edit a channel**

Press on the channel that has been configured and it may be edited.

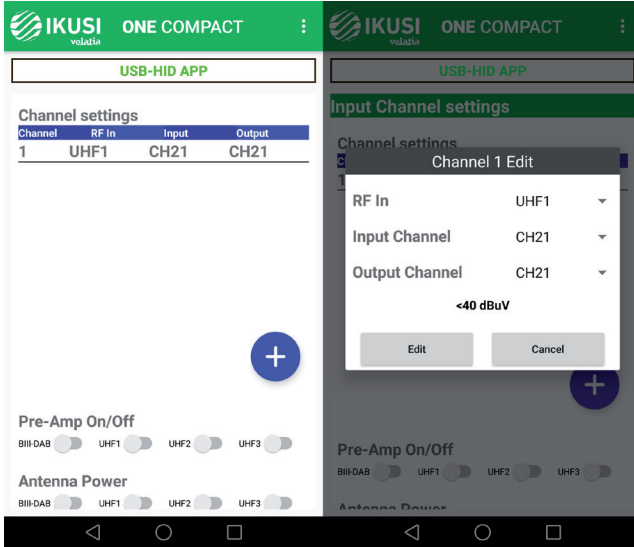

NOTE

A specific aerial input will block part of the band when a channel is added. In the following example, a BIII channel is blocked on the UHF band. In other words, users may only select from channels 21 to 69 on the UHF 1 input and another channel will not be able to be added that is not involved in the UHF 1 band.

If the user wants to receive another band channel, another input may be used to add the specific channel:

- UHF1: 474-858 MHz (CH21-69) FULL band
- UHF2: 474-770 MHz (CH21-58) 4G filter
- UHF3: 474-690 MHz (CH21-48) 5G filter

To prevent signal overlap, the output channel cannot be duplicated. The application will not let this happen, preventing a duplicated channel from being programmed in the output.

Pre-Amp On/Off: It turns the pre-amplifier that is on each RF input on or off.

Pre-amplifier power: It turns the 12V power on for a mast amplifier.

FM Pre-Amp: It turns the FM stage on or off.

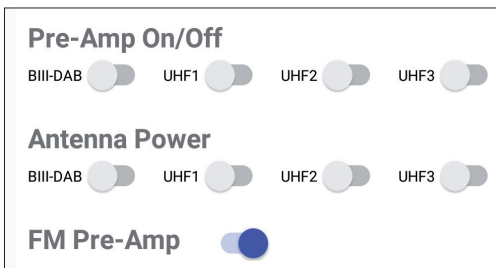

Recommendation: Turn on the pre-amplifier only when the input signal level is too low (below 60 dB μ V). Users may consult the automatic power level measurement of the input signal when adding a channel on the ONE Compact.



NOTE

If the target channel's signal level is low, but other channels on the same input have a high level, these could be saturating the pre-amplifier and causing bad signal quality. Consult the quality of all the reception channels to decide whether to turn the pre-amplifier on or not.

3.3.2 Output adjustments (Output level/Slope)

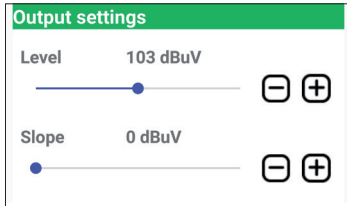

- The output level may be adjusted between 93 and 113 dB μ V
- The slope may be adjusted between 0 and -9 dB

The more channels that are added, the lower the output power will be that must be adjusted.

3.3.3 Maintenance

Software update:

In order to update the software, press the **OK** button in Software updating on the following page.

Then press **Select file** to choose the correct file and then on the **OK** button, followed by **Yes** to start the update.

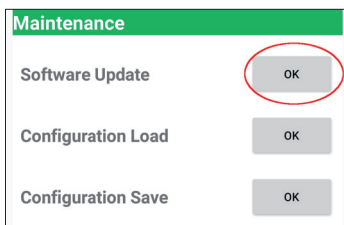

There are three different types of software updates that may be performed:

- **Channel filter:** This affects the behaviour of the filters.
- **MCU:** This update affects the behaviour of the system.
- **Table of frequencies:** This update affects the channels that depend on the chosen country or region.

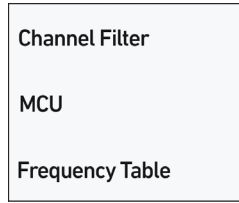
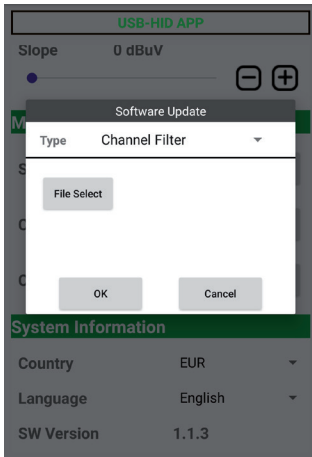

Once the type of update has been chosen, look for the *.bin file and press **OK** button



NOTE

If the SW update is needed, the software package must be placed in the “Download” folder of your android device as shown below.

The names of the software packages are as follows:

- OneCompact_sw_upgrade.bin for Channel filter
- OneCompact_mcu_upgrade.bin for MCU
- OneCompact_frequencyTable_upgrade.bin for Frequency table

• Saving the configuration

To save the configuration, press the **OK** button for “Save configuration” under the “Maintenance” heading

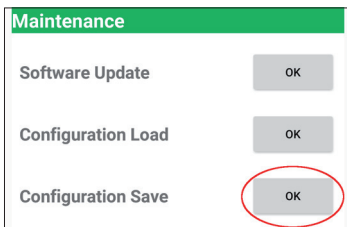

The configuration file will be saved with the name “OneCompact_configuration.bin” in the “Download” folder of the Android device.

- Loading the configuration

To load the previously saved configuration, press the **OK** button for “Download configuration”

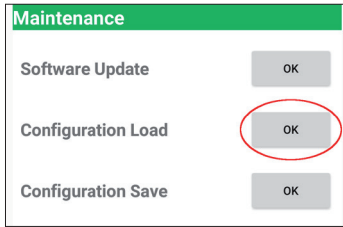

A warning message will be shown indicating that the unit's current configuration will be deleted and the new configuration will be applied. Press the **Yes** button to continue with the process.

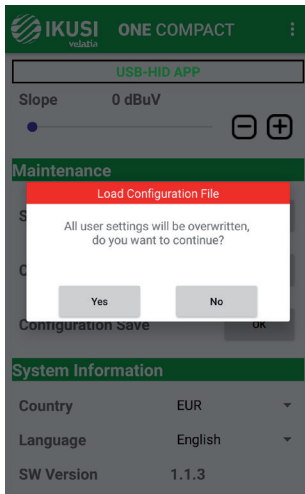

Once accepted, the operation will need a few seconds for processing

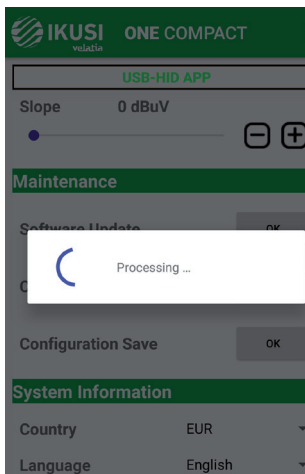

When this operation is applied, a message indicating this will be shown.

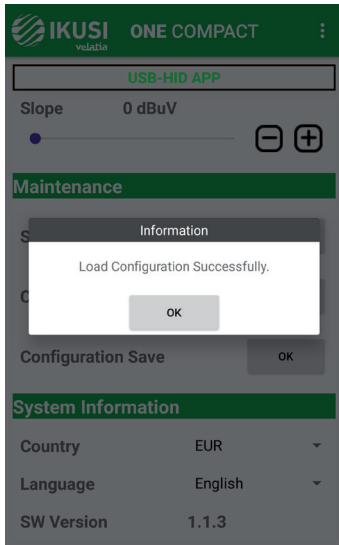

3.3.4. System information

This part shows the unit's information and version. In the Country selection, choose the country or region where you are currently located, the unit will load the corresponding channels according to this.

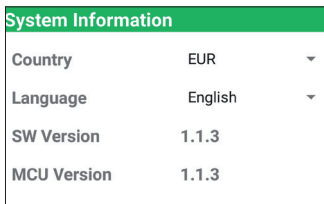

- BRA → Brazil
- EUR → Europe
- THA → Thailand
- NZL → New Zealand
- AUS → Australia
- MEX → Mexico

3.3.5. Restoring the default settings

This sub-menu deletes the unit's current configuration, loading the default configuration, with the set up it had when it left the factory.

⚠ Take care when using this option as the entire previous configuration will be lost. To implement this option, press **OK**.

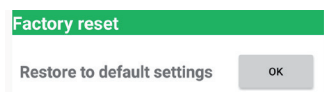

4. LIST OF CHANNELS AND FREQUENCIES

4.1 Europe

Channel	Frequency (MHz)	BW
5	177.5	7
6	184.5	7
7	191.5	7
8	198.5	7
9	205.5	7
10	212.5	7
11	219.5	7
12	226.5	7
21	474	8
22	482	8
23	490	8
24	498	8
25	506	8
26	514	8
27	522	8
28	530	8
29	538	8
30	546	8
31	554	8
32	562	8
33	570	8
34	578	8
35	586	8
36	594	8
37	602	8
38	610	8
39	618	8
40	626	8
41	634	8

Channel	Frequency (MHz)	BW
42	642	8
43	650	8
44	658	8
45	666	8
46	674	8
47	682	8
48	690	8
49	698	8
50	706	8
51	714	8
52	722	8
53	730	8
54	738	8
55	746	8
56	754	8
57	762	8
58	770	8
59	778	8
60	786	8
61	794	8
62	802	8
63	810	8
64	818	8
65	826	8
66	834	8
67	842	8
68	850	8
69	858	8

4.2 Australia

Channel	Frequency (MHz)	BW
6	177.5	7
7	184.5	7
8	191.5	7
9	198.5	7
9A	205.5	7
10	212.5	7
11	219.5	7
12	226.5	7
28	529.5	7
29	536.5	7
30	543.5	7
31	550.5	7
32	557.5	7
33	564.5	7
34	571.5	7
35	578.5	7
36	585.5	7
37	592.5	7
38	599.5	7
39	606.5	7
40	613.5	7
41	620.5	7
42	627.5	7
43	634.5	7
44	641.5	7

Channel	Frequency (MHz)	BW
45	648.5	7
46	655.5	7
47	662.5	7
48	669.5	7
49	676.5	7
50	683.5	7
51	690.5	7
52	697.5	7
53	704.5	7
54	711.5	7
55	718.5	7
56	725.5	7
57	732.5	7
58	739.5	7
59	746.5	7
60	753.5	7
61	760.5	7
62	767.5	7
63	774.5	7
64	781.5	7
65	788.5	7
66	795.5	7
67	802.5	7
68	809.5	7
69	816.5	7

4.3 New Zealand

Channel	Frequency (MHz)	BW
16	514	8
27	522	8
28	530	8
29	538	8
30	546	8
31	554	8
32	562	8
33	570	8
34	578	8
35	586	8
36	594	8
37	602	8
38	610	8
39	618	8
40	626	8
41	634	8
42	642	8
43	650	8
44	658	8
45	666	8
46	674	8
47	682	8

Channel	Frequency (MHz)	BW
48	690	8
49	698	8
50	706	8
51	714	8
52	722	8
53	730	8
54	738	8
55	746	8
56	754	8
57	762	8
58	770	8
59	778	8
60	786	8
61	794	8
62	802	8
63	810	8
64	818	8
65	826	8
66	834	8
67	842	8
68	850	8
69	858	8

4.4 Mexico

Channel	Frequency (MHz)	BW
7	177	6
8	183	6
9	189	6
10	195	6
11	201	6
12	207	6
13	213	6
14	473	6
15	479	6
16	485	6
17	491	6
18	497	6
19	503	6
20	509	6
21	515	6
22	521	6
23	527	6
24	533	6
25	539	6
26	545	6
27	551	6
28	557	6
29	563	6
30	569	6
31	575	6
32	581	6
33	587	6
34	593	6
35	599	6
36	605	6
37	611	6
38	617	6

Channel	Frequency (MHz)	BW
39	623	6
40	629	6
41	635	6
42	641	6
53	647	6
44	653	6
45	659	6
46	665	6
47	671	6
48	677	6
49	683	6
50	689	6
51	695	6
52	701	6
53	707	6
54	713	6
55	719	6
56	725	6
57	731	6
58	737	6
59	743	6
60	749	6
61	755	6
62	761	6
63	767	6
64	773	6
65	779	6
66	785	6
67	791	6
68	797	6
69	803	6

4.5 Brazil

Channel	Frequency (MHz)	BW
7	177.143	6
8	183.143	6
9	189.143	6
10	195.143	6
11	201.143	6
12	207.143	6
13	213.143	6
14	473.143	6
15	479.143	6
16	485.143	6
17	491.143	6
18	497.143	6
19	503.143	6
20	509.143	6
21	515.143	6
22	521.143	6
23	527.143	6
24	533.143	6
25	539.143	6
26	545.143	6
27	551.143	6
28	557.143	6
29	563.143	6
30	569.143	6
31	575.143	6
32	581.143	6
33	587.143	6
34	593.143	6
35	599.143	6
36	605.143	6
37	611.143	6
38	617.143	6

Channel	Frequency (MHz)	BW
39	623.143	6
40	629.143	6
41	635.143	6
42	641.143	6
53	647.143	6
44	653.143	6
45	659.143	6
46	665.143	6
47	671.143	6
48	677.143	6
49	683.143	6
50	689.143	6
51	695.143	6
52	701.143	6
53	707.143	6
54	713.143	6
55	719.143	6
56	725.143	6
57	731.143	6
58	737.143	6
59	743.143	6
60	749.143	6
61	755.143	6
62	761.143	6
63	767.143	6
64	773.143	6
65	779.143	6
66	785.143	6
67	791.143	6
68	797.143	6
69	803.143	6

4.6 Thailand

Channel	Frequency (MHz)	BW
5	177.5	7
6	184.5	7
7	191.5	7
8	198.5	7
9	205.5	7
10	212.5	7
11	219.5	7
12	226.5	7
21	474	8
22	482	8
23	490	8
24	498	8
25	506	8
26	514	8
27	522	8
28	530	8
29	538	8
30	546	8
31	554	8
32	562	8
33	570	8
34	578	8
35	586	8
36	594	8
37	602	8
38	610	8
39	618	8
40	626	8
41	634	8

Channel	Frequency (MHz)	BW
42	642	8
43	650	8
44	658	8
45	666	8
46	674	8
47	682	8
48	690	8
49	698	8
50	706	8
51	714	8
52	722	8
53	730	8
54	738	8
55	746	8
56	754	8
57	762	8
58	770	8
59	778	8
60	786	8
61	794	8
62	802	8
63	810	8
64	818	8
65	826	8
66	834	8
67	842	8
68	850	8
69	858	8

5. EQUIPMENT RECYCLING



RECYCLING OF ELECTRICAL AND ELECTRONIC EQUIPMENT

(Applicable in the European Union and in European countries with selective waste collection systems.)

This symbol on your equipment or its packaging indicates that this product cannot be treated as general domestic waste and must be handed in at the corresponding point of collection for electric and electronic equipment. By ensuring this product is disposed of correctly you will help prevent negative consequences for the environment and human health, which could otherwise be caused by inappropriate waste handling of this product. Recycling of materials helps preserve natural resources. For more detailed information on the recycling of this product, please contact your local council, your nearest collection point or the distributor from whom you purchased the product.



Donostia Ibilbidea, 28
20115 Astigarraga,
Gipuzkoa · España
Tel.: +34 943 44 88 95
television@ikusi.com
·www.ikusi.tv